

Verity Audio reserves the right to make any changes to the product specifications without prior notice.
Final specifications to be found in the user manual.

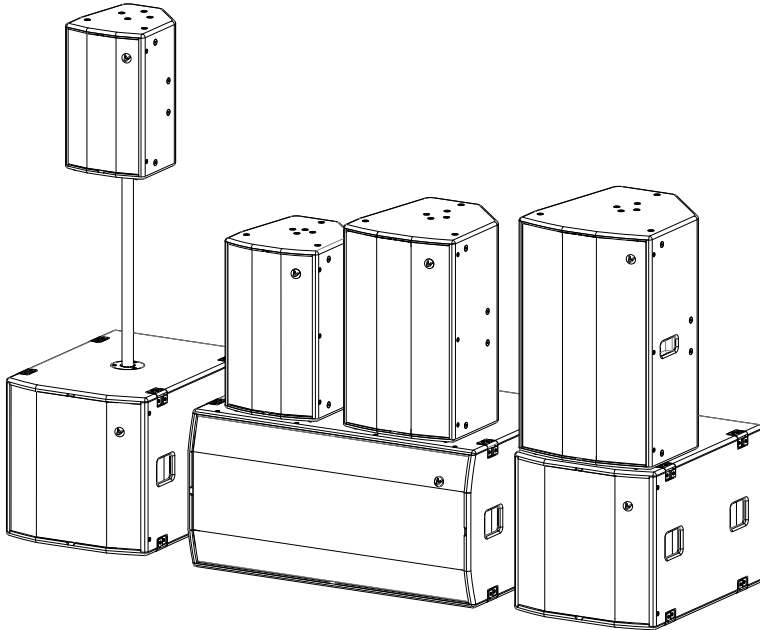



MUSE P *active loudspeaker series*

User's manual

SPECIFICATIONS

Thank you for purchasing the MUSE P series active loudspeaker system. Designed with European customize speaker, MUSE P series active loudspeaker have a very flat frequency response in it working frequency range, high frequency and low frequency have a smooth connection by the right X-over point, it's very good for near field amplification. MUSE P series can output a very deep and warm low frequency when install close to the wall, because of special designed of the vent in cabinet. The SUB P series active subwoofer used the 15" european customize woofer which is specially used for MUSE P series full frequency loudspeaker. SUB P series active subwoofer can output very deep and warm sound when it near the wall because of special designed of the vent in cabinet.



MUSE8P



MUSE10P



MUSE12P



MUSE15P

Model	MUSE8P	MUSE10P	MUSE12P	MUSE15P
Input Sensitivity(v):	1	1	1	1
Max SPL(dB):	116	116	121	122
*Short term max SPL(dB):	122	122	127	128
Frequency Range(-10dB):	50~20kHz	47~20kHz	42~20kHz	40~20kHz
Frequency Response(-6dB):	55~18kHz	50~18kHz	46~19kHz	43~19kHz
Diffusion Angle:	H90°xV60°	H90°xV60°	H90°xV60°	H90°xV60°
AC Power Input:	Universal power supply 96~265 VAC, 50 to 60 Hz			
Speaker Drivers LF:	1x8"(V.C:1.8")	1x10"(V.C:1.8")	1x12"(V.C:2")	1x15"(V.C:2.5")
HF:	1x1"(V.C:1")	1x1"(V.C:1")	1x1"(V.C:1.4")	1x1"(V.C:1.4")
Amplifier:	400W Class D	600W Class D	800W Class D	800W Class D
Cooling:	passive	passive	passive	passive
Connector	1x Locking IEC power connector ; 2xXLR audio input ; 1xcombo MIC input			
Cabinet	CNC tongue and groove cabinet wood Environmental surface treatment			
Product dimension(mm)	280x330x460	330x380x540	395x450x640	470x520x740
Packing dimension(mm)	407x357x533	457x407x616	547x492x733	617x567x833
N.W/G.W	14.2kg/16.9kg	17.2kg/21.2kg	23.8kg/31.3kg	30.4kg/40.3kg
P/N:	060200000144000	060200000145000	060200000146000	060200000147000

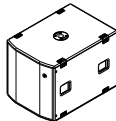

SUB115P

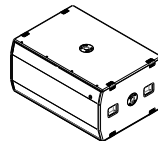

SUB215P

Model	SUB115P	SUB215P
Input Sensitivity(v):	1	1
Max SPL(dB):	123	126
*Short term max SPL(dB):	129	132
Frequency Range(-10dB):	40~150Hz	40~150Hz
Frequency Response(-6dB):	45~150Hz	45~150Hz
AC Power Input:	Universal power supply 96~265 VAC, 50 to 60 Hz	
Speaker Drivers :	1x15"(V.C:3")	2x15"(V.C:3")
Amplifier:	860W Class D	2x860W Class D
Cooling:	passive	passive
Connector	1x Locking IEC power connector ; 2xXLR audio input	
Cabinet	CNC tongue and groove cabinet wood Environmental surface treatment	
Product dimension(mm)	500x700x500	1000x700x500
Packing dimension(mm)	797x597x593	797x597x1093
N.W/G.W	36.5kg/44.6kg	65.1kg/74.8kg
P/N:	060200000170000	060200000150000

*Peak level at 1 m under half space
All specifications are subject to change without notice.

MUSE8P/10P12P/15P

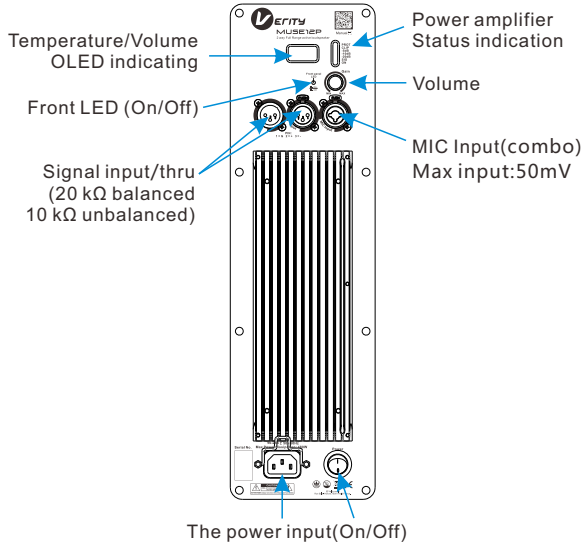

SUB115P/SUB215P

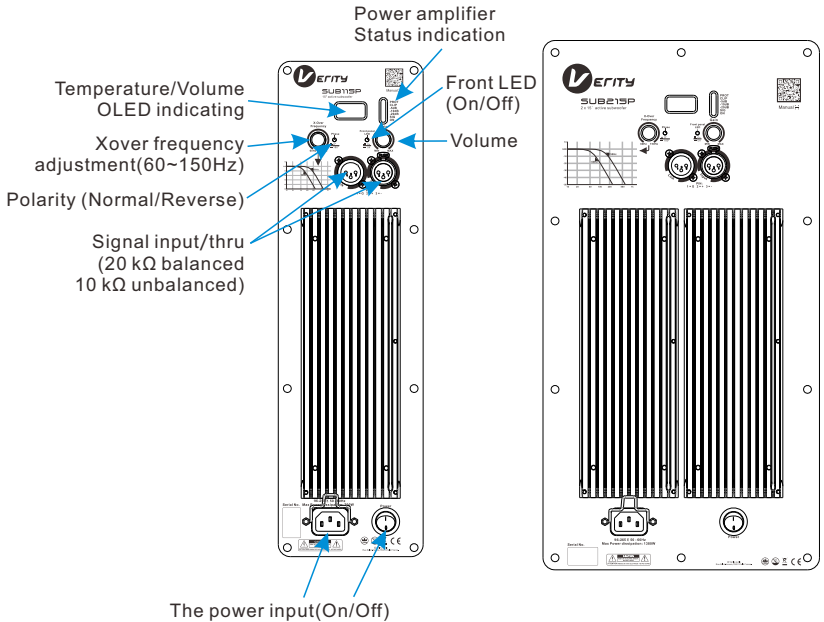

INSTALLATION

Angle adjustment:

MUSE P series loudspeaker have a rotatable horn, so you can adjust it by yourself when you need to change the angle.

Default angle:
Horizon 90°
Vertical 60°

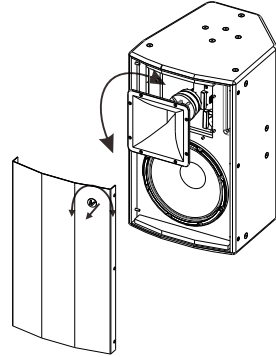

Logo Angle adjustment:

MUSE series loudspeaker have a rotatable Logo. Pull out the logo 3 to 6 mm gently and then rotate it

Hanging:

MUSE series loudspeaker has M8 flying points, you need to remove the screws of the flying points when need to hang the loudspeaker.



And must check if all the screws are screw in to the flying points after installation, if not it may cause air leakage and make sound worse.

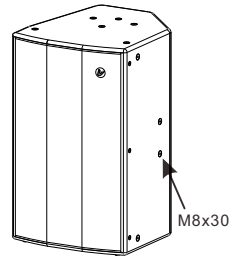

Support:

With M20 inner thread aluminum chassis seat Loudspeaker support rod with M20 thread.

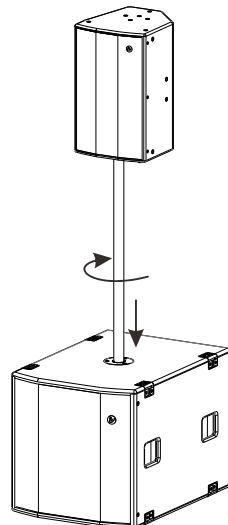

Install loudspeaker with bracket:

Choose the right flying points and install with bracket*.



There is no bracket in the package, please purchase by yourself.

To achieve the best low frequency response, should assemble the cabinet close to the corner. The back hole of the cabinet should be keep 20-30cm from the wall.

Fuse&Adjust the angle

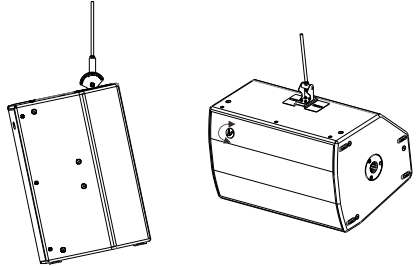

Install loudspeaker with eye bolt:

Choosing the right flying points and install with eye bolt.

When installation try your best to make cabinet close to the wall 20cm to 30cm , that can improve the bass performance.



M8x30 eye bolt

There is no eye bolt (M8x30mm) in the package, please purchase by yourself.



To achieve the best low frequency performance, should assemble the cabinet close to the corner. The back hole of the cabinet should be keep 20-30cm from the wall.

